

STARTING PRESSURE

UNIDIRECTIONAL VALVE

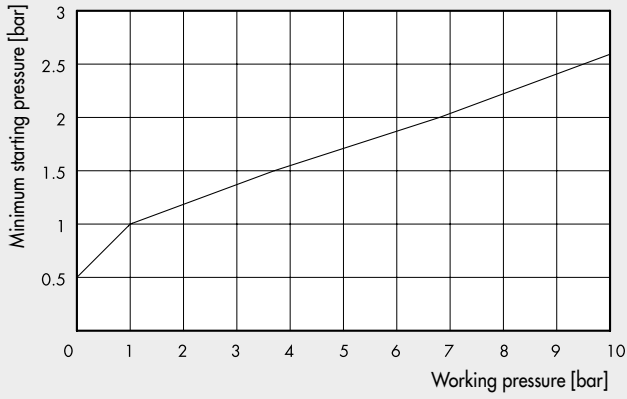

BIDIRECTIONAL VALVE

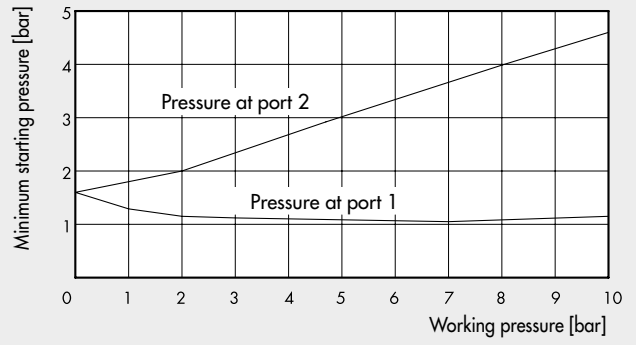

BIDIRECTIONAL THREADED STOP VALVE

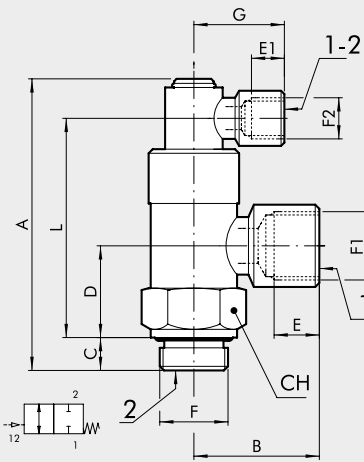

Code	Description	F	F1	F2	A	B	C	D	E	E1	G	L	CH
W6001101001	STP-B 1/8 108	G 1/8	G 1/8	G 1/8	57.5	21.5	6.9	16	7	7	21.5	41.9	14
W6001111011	STP-B 1/4 104	G 1/4	G 1/4	G 1/8	65.7	25.5	8	19.5	8	7	21.5	48.1	17
W6001121021	STP-B 3/8 138	G 3/8	G 3/8	G 1/8	70.9	31	8	22.3	10	7	21.5	53.3	22
W6001131031	STP-B 1/2 112	G 1/2	G 1/2	G 1/8	83.5	40	12	27	14	7	21	61.5	27
W6001141041	STP-B 3/4 134	G 3/4	G 3/4	G 1/8	93.5	39	12	32.5	16	7	21	74	32

THREAD + PIPE BIDIRECTIONAL STOP VALVE

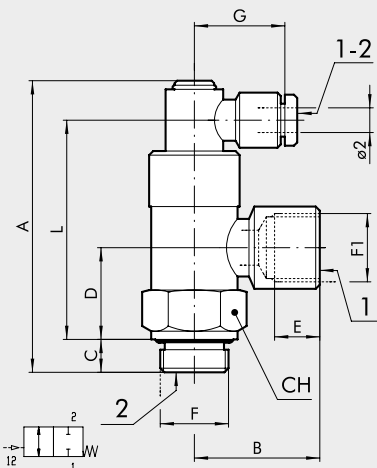

Code	Description	F	F1	Ø 2	A	B	C	D	E	G	L	CH
W6001101002	STP-BX 1/8-1/8 04	G 1/8	G 1/8	4	57.5	21.5	6.9	16	7	25	41.9	14
W6001111012	STP-BX 1/4-1/4 04	G 1/4	G 1/4	4	65.7	25.5	8	19.5	8	25	48.1	17
W6001121022	STP-BX 3/8-3/8 04	G 3/8	G 3/8	4	70.9	31	8	22.3	10	25	53.3	22

PIPE BIDIRECTIONAL STOP VALVE

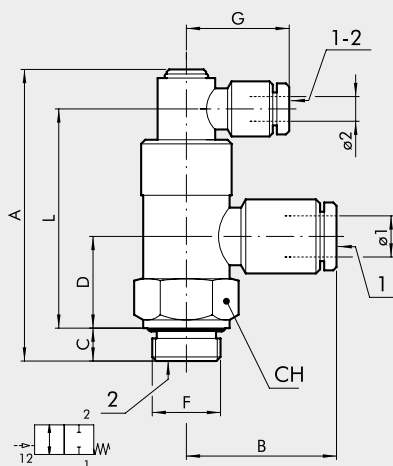

Code	Description	F	Ø 1	Ø 2	A	B	C	D	G	L	CH
W6001101106	STP-B 1/8 006	G 1/8	6	4	57.5	25	6.9	16	25	41.9	14
W6001111106	STP-B 1/4 006	G 1/4	6	4	65.7	27.5	8	19.5	25	48.1	17
W6001111108	STP-B 1/4 008	G 1/4	8	4	65.7	32	8	19.5	25	48.1	17
W6001121108	STP-B 3/8 008	G 3/8	8	4	70.9	31.5	8	22.3	25	53.3	22
W6001121110	STP-B 3/8 010	G 3/8	10	4	70.9	36.5	8	22.3	25	53.3	22
W6001131112	STP-B 1/2 012	G 1/2	12	4	83.5	41.5	12	27	25	71.5	27

UNIDIRECTIONAL THREADED STOP VALVE

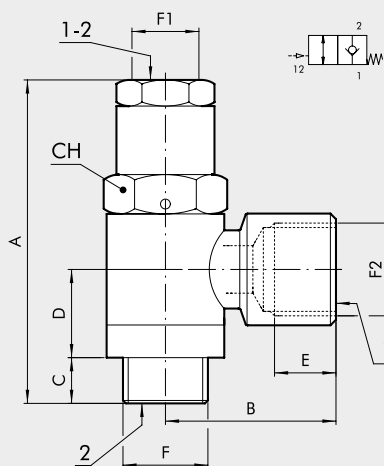

Code	Description	F	F2	A	B	C	D	E	F1	CH
W6001001001	STP-U 1/8 108	G 1/8	G 1/8	43.5	21.5	6	13	7	M5	14
W6001011011	STP-U 1/4 114	G 1/4	G 1/4	49.5	25.5	7	13.5	8	G 1/8	17
W6001021021	STP-U 3/8 138	G 3/8	G 3/8	54.9	31	9	15	10	G 1/8	19
W6001031031	STP-U 1/2 112	G 1/2	G 1/2	61.5	40	10	17	14	G 1/8	24
W6001041041	STP-U 3/4 134	G 3/4	G 3/4	69	39	12	18.5	14	G 1/8	36

UNIDIRECTIONAL PIPE STOP VALVE

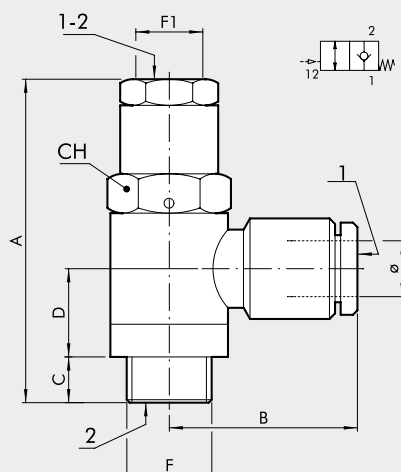

Code	Description	F	Ø	A	B	C	D	F1	CH
W6001001106	STP-U 1/8 006	G 1/8	6	43.5	25	6	13	M5	14
W6001011106	STP-U 1/4 006	G 1/4	6	49.5	27.5	7	13.5	G 1/8	17
W6001011108	STP-U 1/4 008	G 1/4	8	49.5	32	7	13.5	G 1/8	17
W6001021108	STP-U 3/8 008	G 3/8	8	54.9	31.5	9	15	G 1/8	19
W6001021110	STP-U 3/8 010	G 3/8	10	54.9	36.5	9	15	G 1/8	19
W6001031112	STP-U 1/2 012	G 1/2	12	61.4	41.5	10	17	G 1/8	24